

GLOBO

LIGHTING

03651

B

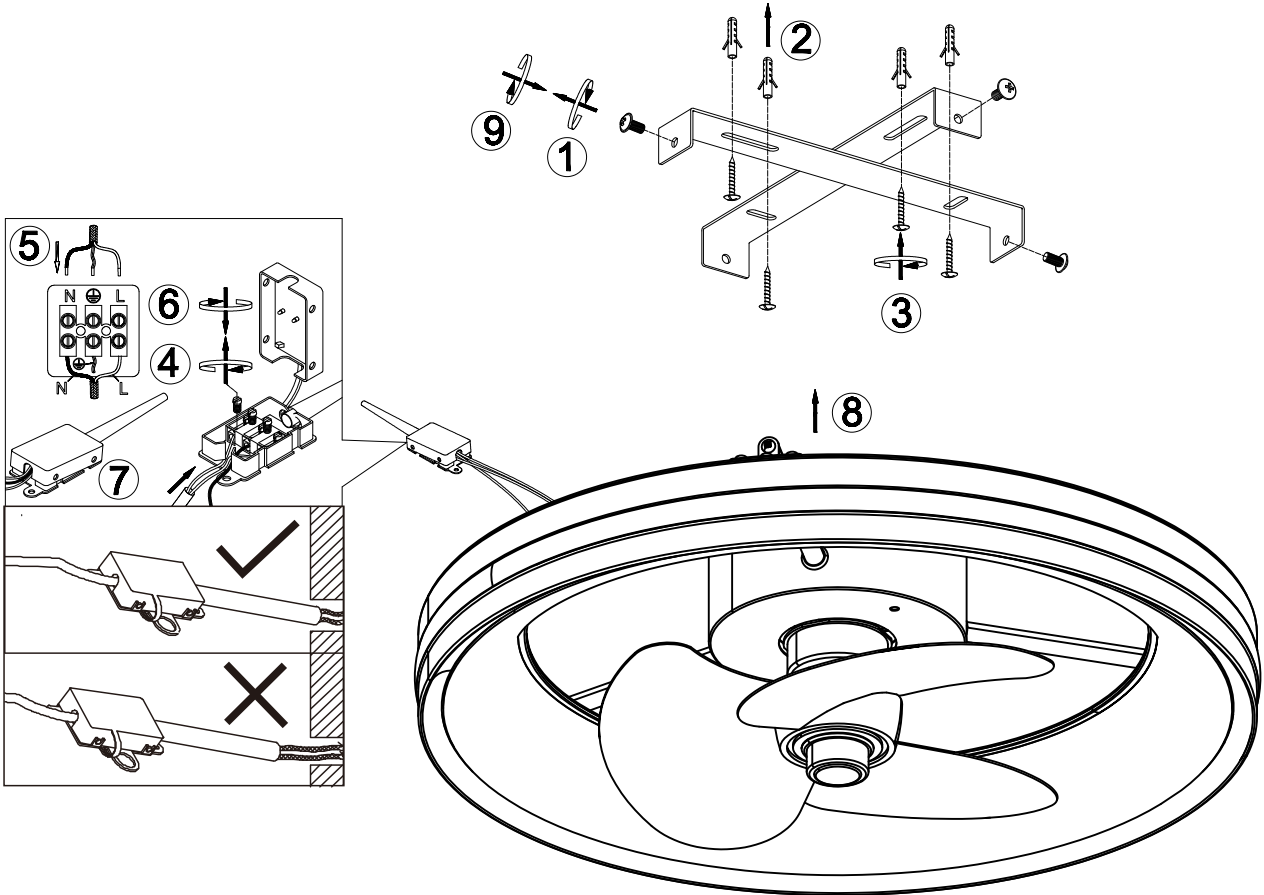

INPUT: 220-240V~ 50/60Hz
 MOTOR: 20W
 OUTPUT: 96-120V
 1x max 30W LED

- 360-2215lm output
- incl. remote control
- 3 LIGHT STEPS (4000 K, 2700 K, 6500 K)
- colour fixing
- dimmable
- 2700 K - 6500 K
- many light steps
- many steps
- timer
- 220-240V~ 50/60Hz
- 7050 1190 1320 Tr/min, 3 Steps
- 20W max.
- 8-15m²
- memory function
- night light
- light distribution diagrams

GLOBO Handels GmbH
 Gewerbestr. 3
 A-9184 Sankt Peter
 Austria
 www.globo-lighting.com
 office@globo-lighting.com

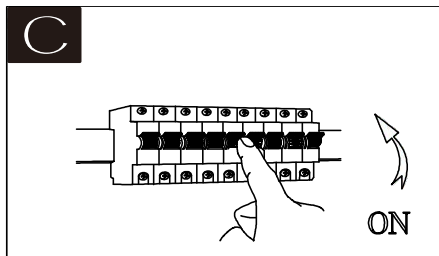

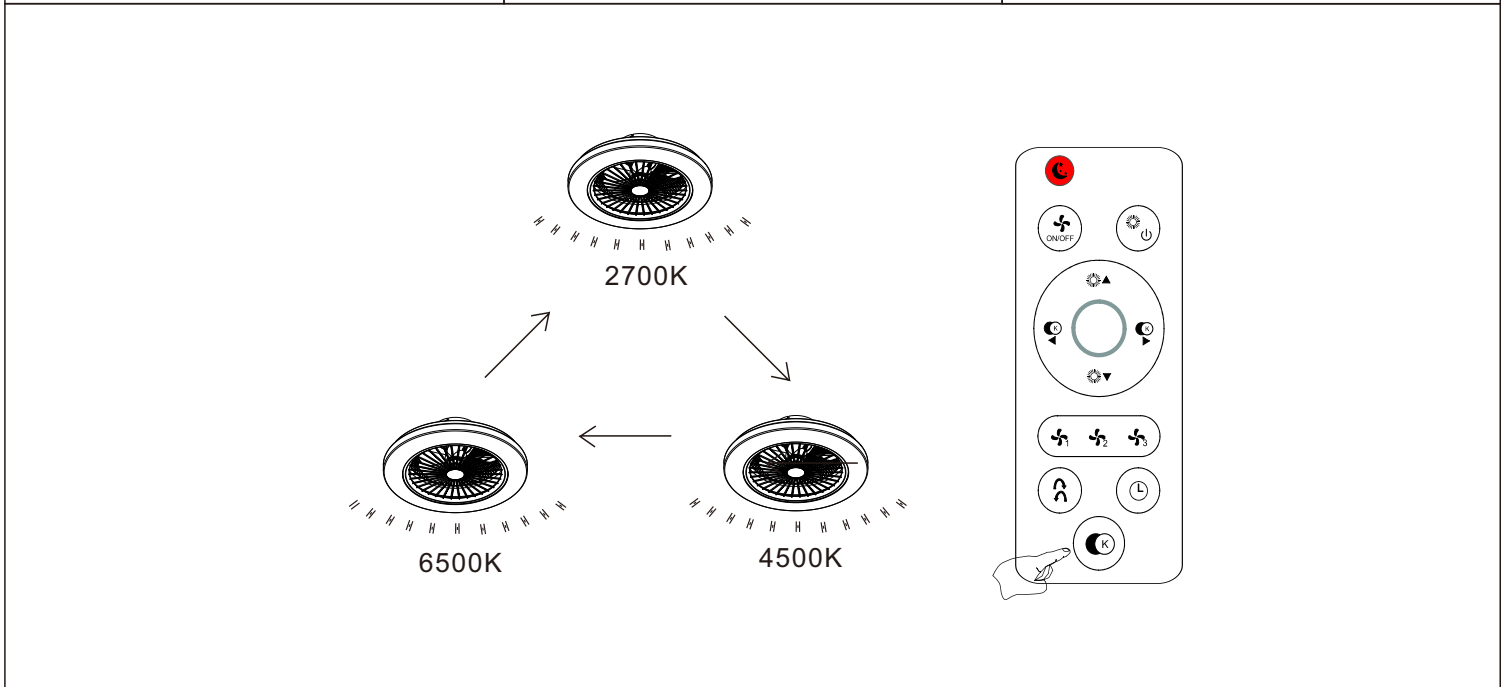
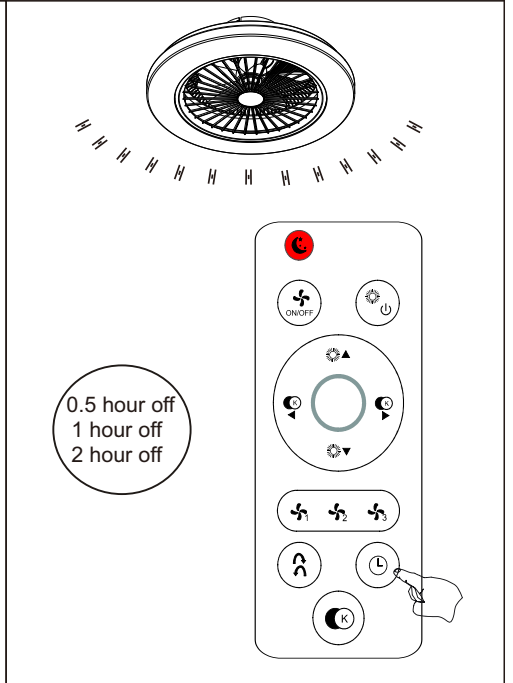
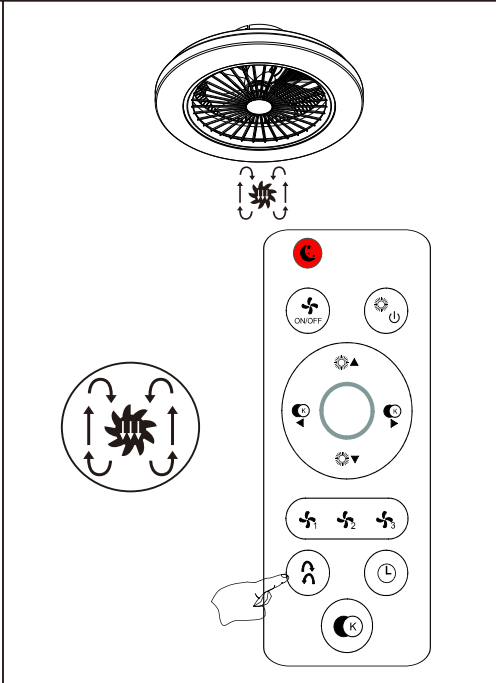
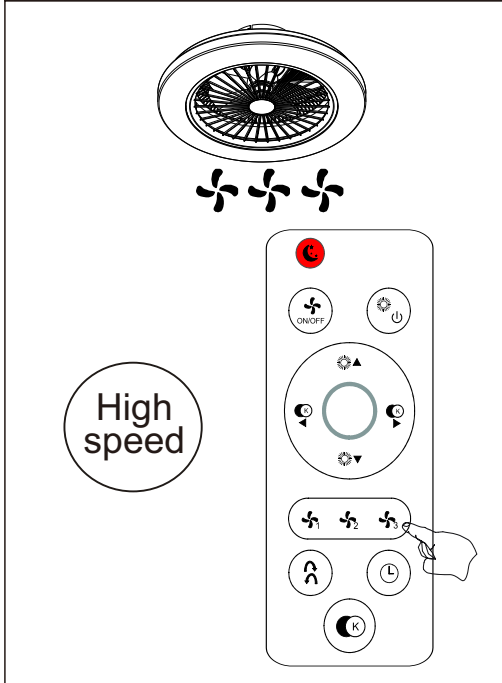
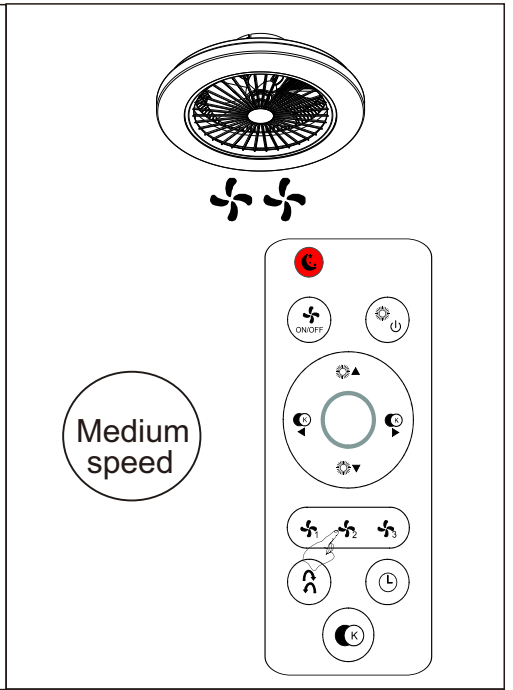
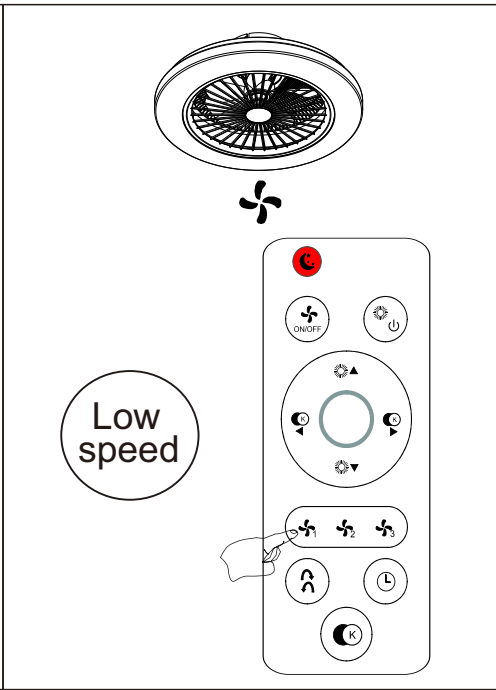
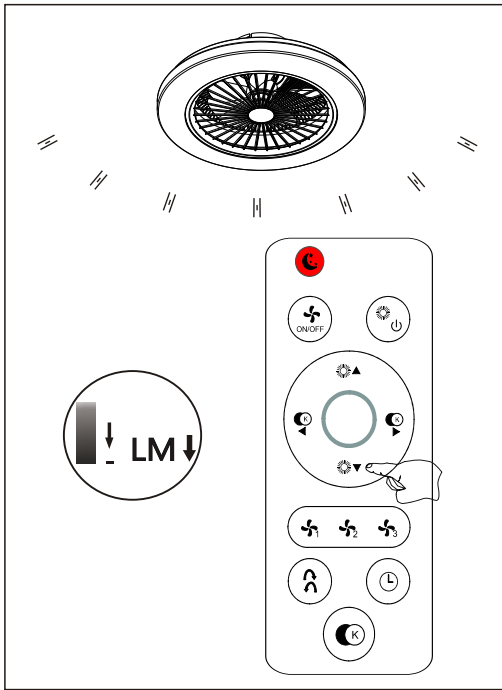

Lichtquelle/Light source:

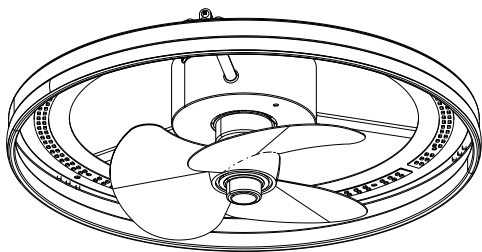

DEU:

Lichtquelle:

Die Lichtquelle ist nicht tauschbar, weil sie konstruktionsbedingt fest mit dem umgebenden Produkt verbunden ist.

Dieses Produkt enthält eine Lichtquelle der Energieeffizienzklasse <F>.

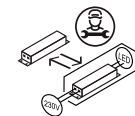

Das Betriebsgerät kann nur durch einen Fachmann ausgetauscht werden.



Die LED - Lichtquelle ist nicht austauschbar.

GBR:

Light source:

The light source is not interchangeable because it is determined by the surrounding product design.

This product contains a light source of energy efficiency class <F>.

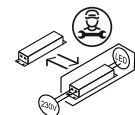

The control gear can be replaced by a professional.

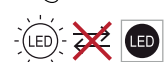

The LED - light source cannot be replaced.

BIH/HR :

Izvor svjetla :

Izvor svjetla nije zamjenjiv , jer je konstrukcijski pričvršćen na proizvod .

Ovaj proizvod sadržava izvor svjetlosti klase energetske učinkovitosti <F>.

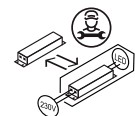

Pogonski uređaj smije zamjeniti samo stručna osoba .

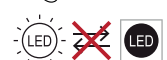

LED – izvor svjetla nije moguće zamjeniti

BG:

Източник на светлина:

Източникът на светлина не може да се подменя, тъй като поради конструкцията си е трайно фиксиран към заобикалящия го продукт.

Този продукт включва светлинен източник с клас на енергийна ефективност <F>.

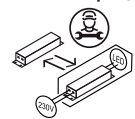

Устройството за управление може да се подменя само от специалист.



LED източникът на светлина не може да се подменя.

CZ:

Zdroj světla:

Světelný zdroj není možné vyměnit, protože je díky své konstrukci pevně spojený s produktem.

Tento výrobek obsahuje světelný zdroj s třídou energetické účinnosti <F>.

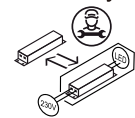

Výměna předřadníku pouze odborníkem



Světelný zdroj není vyměnitelný.

DK:

Lyskilde:

Lyskilden kan ikke udskiftes, fordi den er fast forbundet med det omgivende produkt.

Dette produkt indeholder en lyskilde i energieffektivitetsklasse < F >.

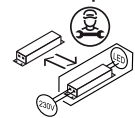

Driftsenheden kan kun skiftes af en fagperson.



LED- lyskilden kan ikke udskiftes.

ET:

Valgusallikas:

Valgusallikas ei ole välja vahetatav, sest ta on tootega ehituslikult kindlalt seotud.

Toode sisaldab energiatõhususe klassi <F> valgusallikat.

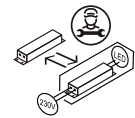

Juhtseadmed võib asendada professionaalne.



LED - valgusallikat ei saa asendada.

FI:
Valonlähde:

Valonlähdettä ei voi vaihtaa uuteen, sillä se on rakenteellisesti yhdistetty ympäröivään tuotteeseen.

Tämä tuote sisältää valonlähteen, jonka energiatehokkuusluokka on <F>.

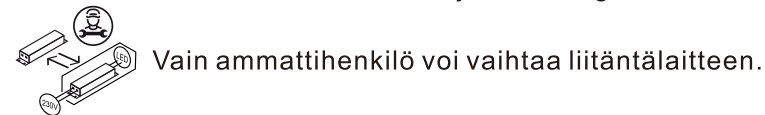

  LED-valonlähdettä ei voi vaihtaa uuteen.

FR:

Source lumineuse:

La source lumineuse n'est pas remplaçable car elle est, de par la construction du produit, liée de façon permanente à celui-ci.

Ce produit contient une source lumineuse de classe d'efficacité énergétique <F>.



  La source lumineuse LED n'est pas remplaçable.

GR:

Φωτεινή πηγή:

Η φωτεινή πηγή δεν μπορεί να αντικατασταθεί, επειδή είναι για κατασκευαστικούς λόγους σταθερά συνδεδεμένη με το προϊόν που την περιβάλλει.

Το προϊόν αυτό περιέχει φωτεινή πηγή της τάξης ενεργειακής απόδοσης <F>.

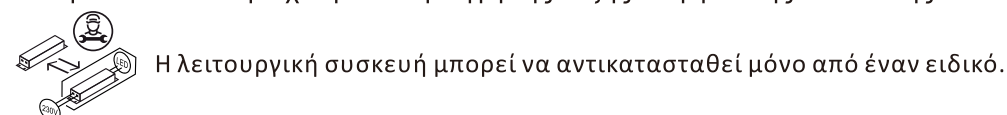

  Η φωτεινή πηγή LED δεν αντικαθίσταται.

HU:

Fényforrás:

A fényforrás nem cserélhető, mert felépítése miatt szilárdan csatlakozik a termékhez.

Ez a termék egy <F> energiahatékonysági osztályú fényforrást tartalmaz.

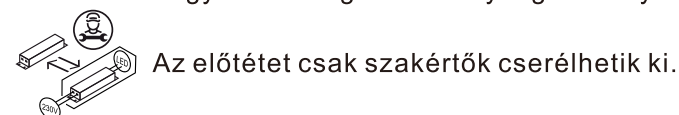

  A fényforrás nem cserélhető.



IS:

Ljósgjafi:

Ljósgjafinn er ekki útskiptanlegur vegna þess að hann er háður umliggjandi hönnun vörunnar.

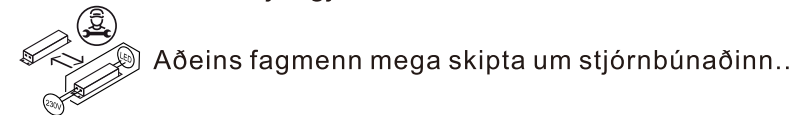
Varan inniheldur ljós gjafa í orkuflokki <F>.



  Ekki er hægt að skipta um LED-ljós gjafann.

IT:

Sorgente luminosa:

La sorgente luminosa non è intercambiabile perché è saldamente collegata al prodotto per via del suo design.

Questo prodotto contiene una sorgente luminosa di classe di efficienza energetica <F>.

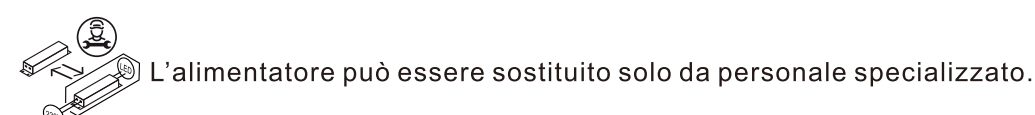

  La sorgente luminosa a LED non può essere sostituita.



LV:

Gaismas avots:

Gaismas avotu nevar nomainīt, jo tas konstrukcijā ir cieši savienots ar izstrādājuma apkārtējo daļu.

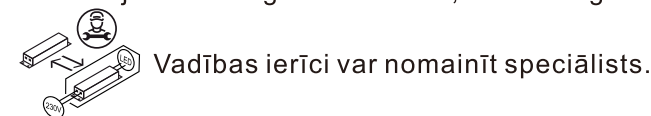
Šis ražojums satur gaismas avotu, kura energoefektivitātes klase ir <F>.



  LED apgaismes līdzekli nevar nomainīt.



LT:

Šviesos šaltinis:

Šis šviesos šaltinis yra nekeičiamas, nes jis prijungtas prie gaminio pagal jo konstrukciją.

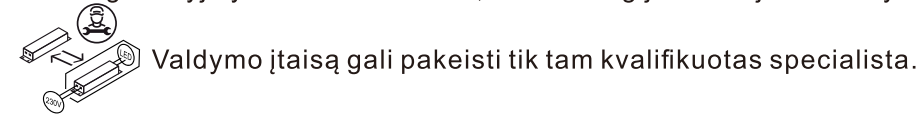
Šiame gaminyje yra šviesos šaltinis, kurio energijos vartojimo efektyvumo klasė <F>.



  LED šviesos šaltinis yra nekeičiamas.

NL:

Lichtbron:
De lichtbron kan niet worden vervangen, omdat deze vanwege de constructie vast met het product eromheen verbonden is.

Dit product bevat een lichtbron van energie-efficiëntieklasse <F>.

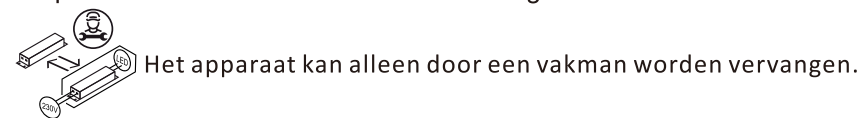

  De LED-lichtbron kan niet worden vervangen.



NO:

Lyskilde:

Lyskilden kan ikke byttes fordi den sitter fast i produktet.

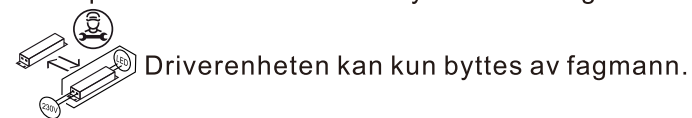
Dette produktet inneholder en lyskilde i energiklasse <F>.



  LED-lyspæren kan ikke byttes.

PL:

Źródło światła:

Źródła światła nie można wymienić, ponieważ jest zintegrowane z produktem ze względu na swoją konstrukcję.

Ten produkt zawiera źródło światła o klasie efektywności energetycznej <F>.

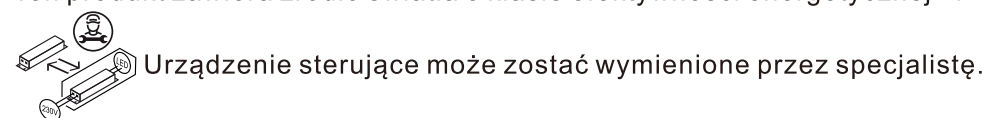

  LED - źródło światła nie może być wymienione.

PT:

Fonte de Luz:

A fonte de luz não é substituível porque devido às suas características construtivas está fixada de forma permanente ao produto circundante.

Este produto contém uma fonte de luz da classe de eficiência energética <F>.

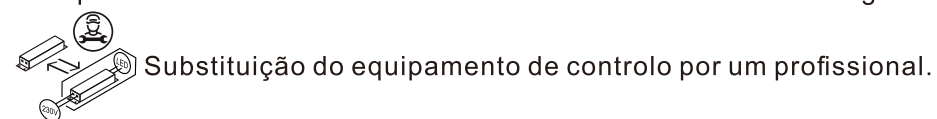

  Lâmpada não substituível.

RO:

Sursa de lumina:

Sursa de lumina nu este inlocuibilă ea fiind parte constructivă a produsului
Acest produs conține o sursă de lumină cu clasa de eficiență energetică <F>.

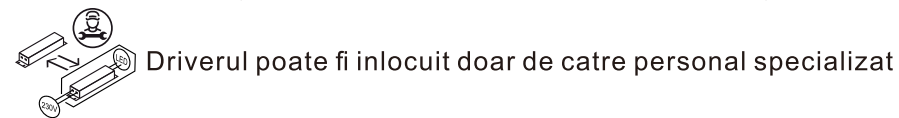

  Sursa de lumina nu poate fi înlocuită

RUS:

Источник света:

Источник света не является взаимозаменяемым, поскольку это определяется конструкцией смежного продукта.

Данный продукт содержит источник света класса энергоэффективности <F>.

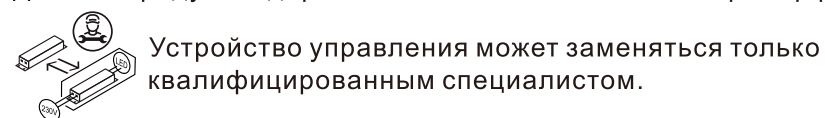

  Светодиодный источник света не подлежит замене.



SRB:

Izvor svetlosti:

Izvor svetlosti nije zamenljiv, jer je zbog svog dizajna čvrsto povezan sa proizvodom koji ga opkružuje.

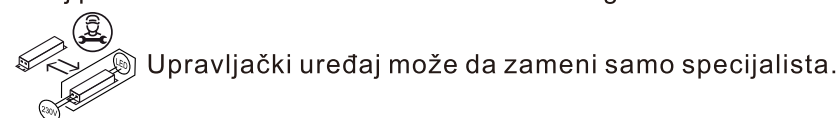
Ovaj proizvod sadrži izvor svetlosti klase energetske efikasnosti <F>.



  LED izvor svetlosti nije zamenljiv.

SK:

Zdroj svetla:

Svetelný zdroj nie je možné vymeniť, pretože je vďaka svojej konštrukcii pevne spojený s produktom.

Tento výrobok obsahuje svetelný zdroj triedy energetickej účinnosti <F>.

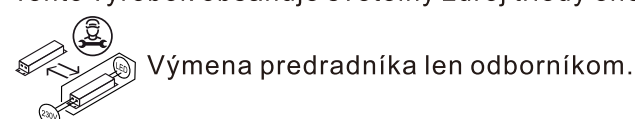

  Svetelný zdroj nie je vymeniteľný.

SI:

Izvor svetlobe:

Vir svetlobe ni zamenljiv, ker je določen z zasnovo izdelka v okolici.

Ta izdelek vsebuje svetlobni vir razreda energijske učinkovitosti <F>.

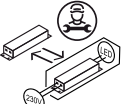
 Krmilno napravo lahko zamenja samo strokovno usposobljena oseba

  Svetlobni vir ni mogoče zamenjati.

ES:

Fuente de luz:

La fuente de luz no es sustituible porque está fija en el producto desde la construcción.

Este producto contiene una fuente luminosa de la clase de eficiencia energética <F>.

 Sustitución del aparato por un profesional.

  Bombilla no reemplazable.

SE:

Ljuskälla:

Ljuskällan är inte utbytbar, eftersom den på grund av konstruktionen är fast integrerad i den omgivande produkten.

Denna produkt innehåller en ljuskälla med energieffektivitetsklass <F>.

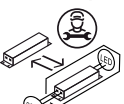
 Driftdonet kan endast bytas ut av en fackman.

  LED-ljuskällan kan inte bytas ut.

TR:

Işık kaynağı:

Konstrüksiyon gereği çevreleyen ürün ile sabit bir şekilde bağlı olduğu için ışık kaynağı değiştirilemez.

Bu ürün, <F> enerji sınıfından bir ışık kaynağına sahiptir.

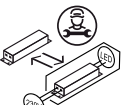
 İşletme cihazı sadece bir uzman tarafından değiştirilebilir.

  LED ışık kaynağı değiştirilemez.

UK:

Джерело світла:

Джерело світла не можна обміняти, оскільки воно міцно пов'язане з навколишнім виробом завдяки своїй конструкції.

Цей виріб містить джерело світла класу енергоефективності <F>.

 – лише фахівець може замінювати пристрій керування.

  – джерело світлодіодного світла не можна замінювати.